

# 100 MeV/100 kW ACCELERATOR ADJUSTMENT FOR THE NSC KIPT NEUTRON SOURCE PHYSICAL START UP

*A. P. Bezditko, A. N. Gordienko, P. I. Gladkikh, A. M. Gvozd, D. A. Kapliy, I. M. Karnaukhov, I. I. Karnaukhov, V. N. Lyashchenko, A. O. Mytsykov, M. P. Moisieienko, V. E. Rudenko, A. V. Ryezayev, D. V. Tarasov, V. I. Trotsenko, A. Yu. Zelinsky* \*

*National Science Center "Kharkiv Institute of Physics and Technology", 61108 Kharkiv, Ukraine*

(Received June 15, 2020)

The NSC KIPT SCA Neutron Source uses 100 MeV/ 100 kW electron linear accelerator as a driver for the generation of the initial neutrons. The individual State tests of the accelerator were successfully carried out in July 2018 and pilot operation of the accelerator was started in autumn 2018. Since then the following were carried out: preparation and providing of the SCA Neutron Source State Integrating tests, adjustment and improvement of the accelerator technological system performance, optimization of the electron beam parameters, preparation to the SCA Neutron Source physical start up. The main results of the accelerator operation and methods of performance improve are described in the paper.

PACS: 87.64.Aa; 29.17.+w

## 1. INTRODUCTION

100 MeV/100 kW electron linear accelerator that is a driver of the ADS NSC KIPT Neutron Source [1,2] was designed and manufactured in IHEP, Beijing, China and assembled in NSC KIPT, Kharkov, Ukraine during 2010-2014 [3, 4]. The design parameters of the accelerator are shown in Table.

*Main KIPT Linac parameters*

| Parameter                   | Value            |
|-----------------------------|------------------|
| RF frequency                | 2856 MHz         |
| Beam energy                 | 100 MeV          |
| Pulse beam current          | 0 ... 0.6 A      |
| Average beam power          | 0.005 ... 100 kW |
| Energy spread ( $1\sigma$ ) | 4 %              |
| Beam pulse length           | 2.7 $\mu$ s      |
| RF pulse duration           | 3 $\mu$ s        |
| Pulse repetition rate       | 2 ... 625 Hz     |
| Gun voltage                 | $\sim$ 120 kV    |
| Gun beam current            | 0 - 1 A          |

In 2015 and 2016 commissioning of the accelerator technological systems and beam tuning were started [5] and in spring 2017 the design value of pulse electron beam current was obtained in the end of the accelerator horizontal part. During the first part of 2018 all accelerator technological systems and control system were prepared for the individual State accepting tests.

In early July 2018, the individual accepting tests were carried successfully. During the tests accelerator

demonstrated the possibility to operate with 50 Hz repetition rate and 600 mA pulse current but the majority of the tests were done with 2 Hz repetition rate and pulse current of about 200 mA.

In late November 2018 the SCA Neutron Source State integrated tests were carried out successfully and in a strict accordance with approved by the Regulator test program. The next stage of the SCA Neutron Source commissioning is preparation of the licensing documentation and facility technological systems to the physical start up and fresh fuel delivery to NSC KIPT.

In spring 2019 the fresh fuel was delivered to NSC KIPT and put in storage. After State integrating tests the main directions of the accelerator staff activity were:

1. Maintenance and preparation to the SCA Neutron Source physical start up of all accelerator technological systems and control system.
2. Conditioning of the high power RF system to provide accelerator design parameters.
3. Providing of the stable, repeatable accelerator operation modes with beam parameters required by the Program of the facility start up.

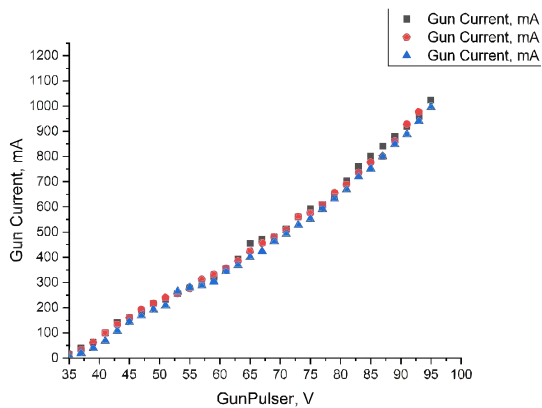
## 2. ACCELERATOR PERFORMANCE IMPROVE

### 2.1. TRIODE ELECTRON GUN

SCA Neutron source 100 MeV/100 kW electron linear accelerator uses triode electron gun with EIMAC Y824 cathode. The first results of beam tests showed

\*Corresponding author E-mail address: zelinsky@kipt.kharkov.ua

the good agreement with design parameters and tests carried out in IHEP, Beijing, China. The gun showed stable current pulse in operation range of 0.2...0.8 A. However, the requirements of the NSC KIPT SCA Neutron Source nuclear facility integrating tests and physical start up arise the necessity to modify the gun pulser to provide the gun operation with low beam current value (down to 10...20 mA). The gun pulser was modified and now the gun can be operated in current range value of 0.02% 1 A. Fig.1 shows the measured current-voltage diagram of the NSC KIPT electron gun for different grid voltage (25, 30, and 35 V). After modification the gun shows stable performance with 10 ns time stability and about 2% pick current stability.



*Fig.1. The current-voltage diagram of the 100 MeV/100 kW electron accelerator triode gun*

## 2.2. BEAM ENERGY SPREAD

To provide efficient electron beam transportation through the accelerator it is necessary to provide design value of the electron beam energy spread that is  $\pm 4\%$ . To obtain such value of energy spread, it is supposed to adjust correct mode of the electron beam phasing in the injection part of the accelerator and along the whole accelerator. Simultaneously, the measurement of the beam energy spectrum should be provided. The original design of the accelerator supposed to install two lame secondary emission monitors after injection part of the accelerator and after the first bending magnet of the transportation channel (TB1). At this stage of the accelerator commissioning to measure beam energy spread means to have possibility to adjust beam energy spread for the facility physical start up and further during pilot operation up to accelerator full power.

During accelerator pilot operation it was found, that graphite lame electrode width and graphite emission capacity is not enough to provide secondary emission signal value for registration. In addition, some errors were done during electronics design and development.

To provide secondary emission signal registrations

all amplifiers were tested and amplifying coefficients were adjusted.

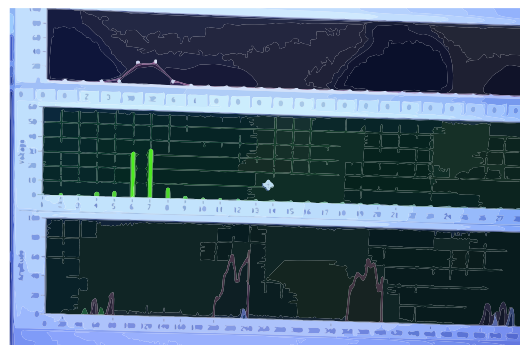
The graphite emitting electrodes were substituted for aluminum 25  $\mu\text{m}$  thickness foil strips with 8 mm width for LSM1 and 3.5 mm width for LSM2. 14 electrodes were installed in LSM1 and 16 electrodes were installed in LSM2. That provides good sensitivity of the electrodes and maximum overlapping of the vacuum chamber aperture (Figs.2,3). After modification and adjustment of LSM1 and LSM2 mechanical parts, electronics and software the measurements of the beam energy spread were done at the injection part of the accelerator and in the middle of transportation channel.



*Fig.2. Modified LSM1*



*Fig.3. Modified LSM2*



*Fig.4. Electron beam energy distribution at LSM1*

The example of the measurement results for LSM1 is shown in Fig.4. Therefore, the operation of both LSM1-2 gave the opportunity to adjust energy spread of the accelerator.

### 3. ACCELERATOR BEAM PARAMETERS ADJUSTMENT

Fig.5 shows the layout of 100 MeV/ 100 kW electron linear accelerator driver of NSC KIPT SCA Neutron Source.

To adjust electron beam parameters and prepare the accelerator to the physical start up the accelerator adjustment was divided for the following stages:

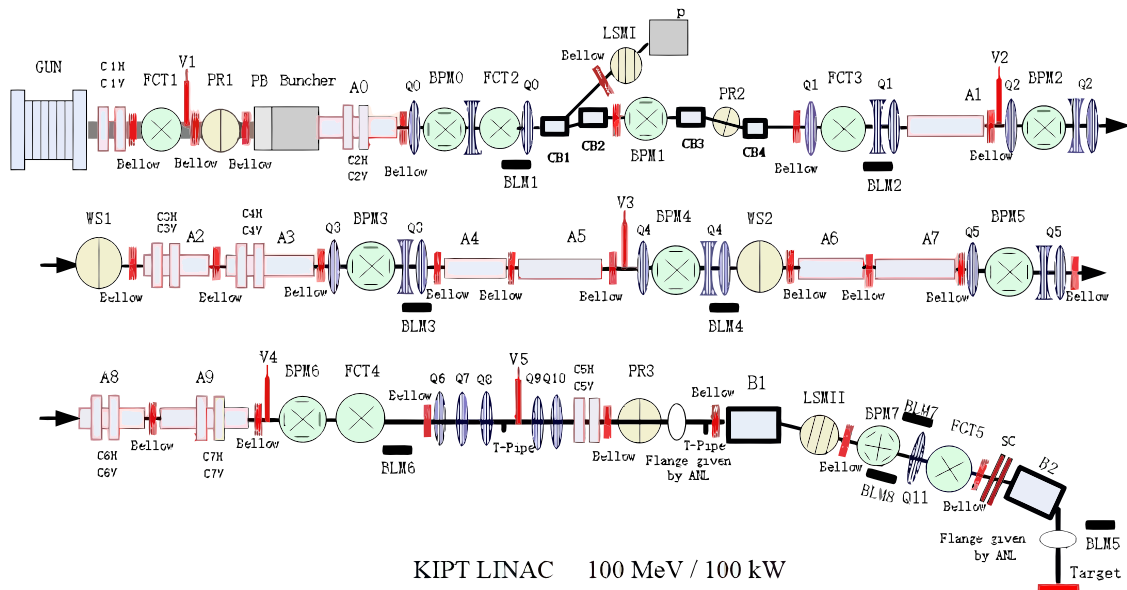
- optimization of the injection part of accelerator that includes triode electron gun, Pre-buncher,

buncher, injection accelerating section A0 with electromagnetic and beam instrumentation equipment (see Fig.5);

- optimization electron beam parameters in electromagnetic chicane (CB1-CB4, collimator and beam instrumentation equipment in Fig.5);

- optimization of the beam parameters and beam passing efficiency during electrons acceleration in horizontal part of the accelerator (accelerating sections A1-A9, electromagnetic triplets and beam instrumentation equipment in Fig.5);

- optimization of the beam transportation through transportation channel (Q7-Q11, TB1-TB2 with beam instrumentation equipment).

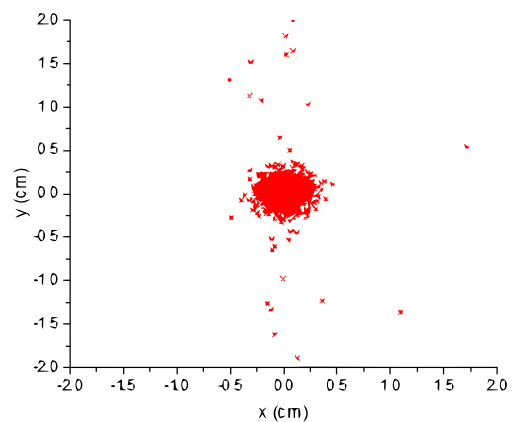


**Fig.5.** Layout of the 100 MeV/100 kW accelerator equipment distribution: GUN is electron gun, C1-7H, C1-7V are horizontal and vertical beam position correctors, FCT1-FCT5 are fast current transformers, V1-5 are vacuum valves, PR1-3 are scintillating screens, PB is pre-buncher, Buncher, A0-9 are accelerating sections, Q0-5 are fo-focusing quadrupole triplets, Q6-11 are transportation channel quadrupoles, BPM0-7 are beam position monitors, CB1-4 are chicane bending magnets, LSM1-2 are lame screen monitors, BLM1-7 are beam loss monitors, B1-2 are transportation channel bending magnets

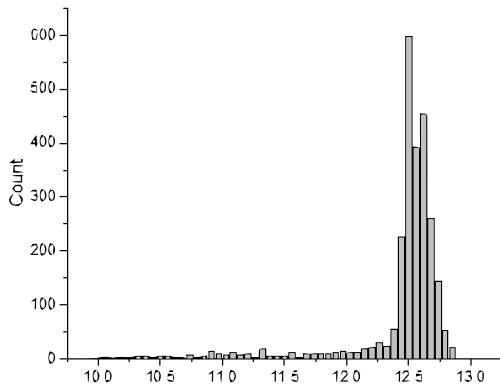
#### 3.1. OPTIMIZATION OF THE PRE-BUNCHER, BUNCHER AND INJECTION SECTION PARAMETERS

A set of simulations has been done to determine the optimal conditions of electron beam bunching and focusing in the injection part of accelerator. The results of optimal electron beam parameters are shown in Figs.6-8. As one can see, the optimal efficiency of the injection in the accelerator is about 91 % (see Fig.6). Figs.7-8 shows that the beam with such injection efficiency has electron energy of about 12.5 MeV with beam energy spread of about 1.5 %. So, the purpose of the electron beam parameters adjustment is to reach the beam parameters that are close to the optimal parameters mentioned above.

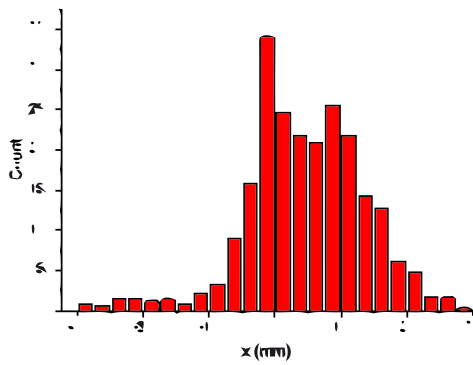
During pre-buncher, buncher and A0 tuning the electron beam was bend to the beam dump with the first chicane bending magnet CB1 (see Fig.5).



**Fig.6.** Simulation results of optimal electron beam size at the exit of A0 injection accelerating section. 2739 particles out of 3000 passed through the injector (91.3 % injection efficiency)

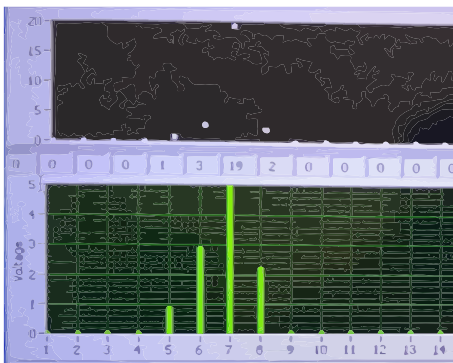


**Fig.7.** Simulation results of optimal electron beam energy distribution at the output of A0 accelerating section (injection section)



**Fig.8.** Electron beam distribution at the LSM1 monitor. Histogram step is 0.25 % of beam energy that corresponds to 2.5 mm beam shift

Electron beam energy spread was monitored with lame monitor LSM1 (see Fig.2). Electron beam energy was registered in accordance with CB1 excitation current, when electron beam position was at the center of LSM1. The beam energy distribution after beam tuning are shown in Fig.9.



**Fig.9.** Energy spectrum of the electron beam after injection section A0

Since LSM1 has 14 strips of 8 mm width each the position of the center reference orbit corresponds to the gap between 7th and 8th strip that is about 1 mm. Because dispersion function value at the position of LSM1 is 1 m each strip to the left and to the right

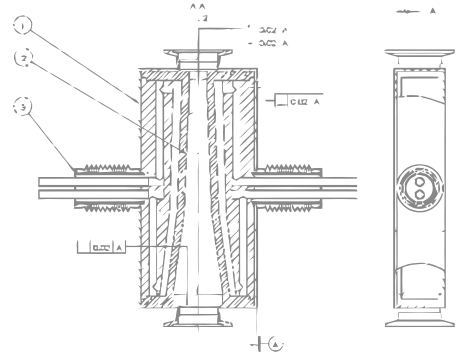
out of monitor center collected the signals of particle with about 1 % energy deviation. CB1 bends electrons to the left and strip numbering is starting from the right side of LSM1. So, the particles with the energy that is lower than reference energy will be collected at 1-7 strips and with energy that is higher than reference energy will be collected by the strips 8-14 (in opposite direction with Fig.8).

As a result of the accelerator adjustment and beam parameter tuning the 12.5 MeV electron beam with average energy spread of about  $\pm 1.5$  % was stably produced. The shape and width value of the beam energy spectrum is in a good agreement with simulation results (see Fig.8).

The electron beam bunching and phasing was done for the different initial gun pulse current in the range of 20...800 mA. The maximum efficiency of the beam injection in the injection A0 section was reached with 100 mA of the gun pulse current and was about 92 %. The average value of the injection efficiency was about 86 %.

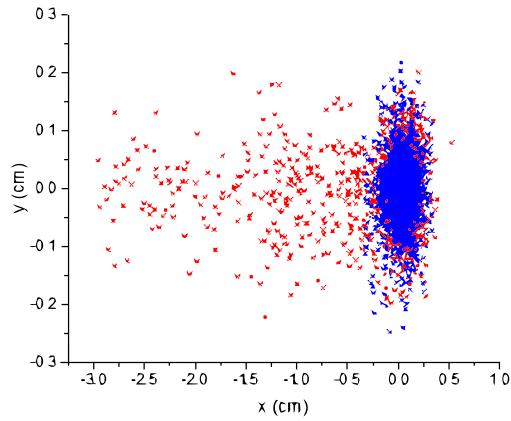
### 3.2. BEAM TRANSPORTATION THROUGH THE CHICANE

The second task after accelerator injection part adjustment was to tune electromagnetic chicane and provide electron beam transportation through the chicane. Because after injection section the beam energy spectrum has low energy tail (see Fig.9), it is necessary to cut beam energy edges within  $\pm 3$  % energy. To provide such opportunity a collimator with controlled horizontal gap width was installed between chicane central bending magnets (Fig.10). The gap width can be controlled in the range of 0...20 mm to the left and to the right independently.

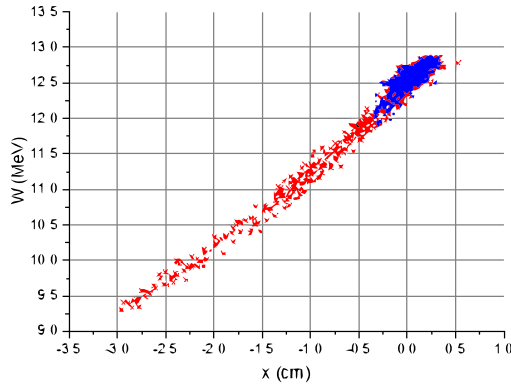


**Fig.10.** Electromagnetic chicane collimator

To estimate electron beam size and necessary collimator aperture for the beam pass with  $\pm 3$  % energy spread the preliminary numerical simulation of the beam parameters in the injection part of the accelerator and electromagnetic chicane has been done. The simulations were done for the round input beam distribution of 2 mm radius in X and Y directions that was simulated by EGUN code. Figs.11, 12 show the simulation results. As one can see, to provide necessary value of energy spread the collimator should be opened with the gap of  $\pm 3$  mm. The estimated efficiency of the beam pass is about 89 %.



**Fig.11.** Transverse electron beam distribution at the entrance and exit of collimator with  $\pm 3$  mm open gap in collimator. Red is the beam at the collimator entrance (2573 particles). Blue is the beam at the collimator exit (2573 particles)



**Fig.12.** Electron energy distribution vs transverse  $x$  coordinate at the entrance and exit of collimator with  $\pm 3$  mm open gap in collimator. Red is the beam at the collimator entrance (2573 particles). Blue is the beam at the collimator exit (2573 particles)

At the beginning of the linac tuning collimator was fully opened. The first attempts to narrow the collimator gap led to the full loss of the beam at collimator and absents of FCT3 current signal. To understand the reason of this effect the collimator alignment and geometry were checked and the electron beam profile at the collimator entrance was measured. The procedure consists of FCT3 beam current measurements with different positions of one of collimator sidewall from 20 to 0mm and fully opened another sidewall and wise versa. The measurement results are shown in Fig.13. As one can see from Fig.13, the center of the electron beam was shifted on about 7 mm to the right that caused the beam losses.

To improve the situation, the electron beam position was corrected with use of the chicane bending magnets (CB1-CB4). The focusing and electron beam distribution was kept the same.

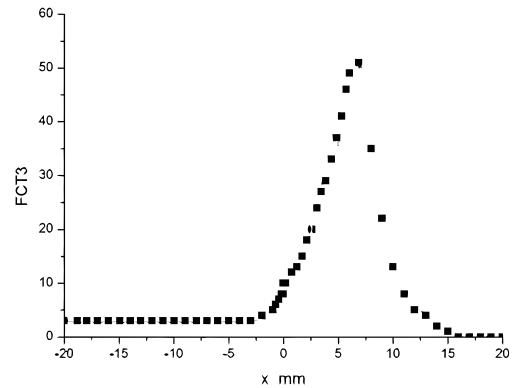
After collimator gap was closed to  $\pm 3$  mm, the average efficiency of the beam transportation trough electromagnetic chicane was 71 %. The maximum

transportation efficiency was about 75 %. The difference between experimental and numerical results can be explained with the difference of real initial beam transversal and energy distributions and ideal beam distribution that was used in simulations or imperfection of beam bunching.

During beam phasing the beam position displacement in depends on Q6-Q11 magnetic field value was registered. Two possible reasons can cause such deviation: inaccurate quadrupole installation or deviation of the initial electron beam position in quadrupoles.

The alignment accuracies of all transportation channel magnetic elements were checked. The positions of elements were installed with accuracy within 100...200  $\mu\text{m}$ .

To provide proper electron beam position correction the layout of beam position correctors was changed as it is shown in Fig.5. Correctors C3H, C3V were moved from A1 to A2 and C6H, C6V from A7 to A8 to create two pairs of correctors that can change not only beam slope angle but also correct beam position without effect of any others focusing magnetic elements. Correctors C5H, C5V were moved from A5 to entrance of TB1 to provide initial beam slope angle correction before the first 45-degree bending part. Such correction scheme allows to separate the task of beam position correction in horizontal and bending parts of accelerator and provides a possibility of beam focusing (Figs.14-16). As one can see, the beam position does not change with switching of focusing lenses that testifies right beam correction. Beam passes focusing lenses right through the magnetic centres.

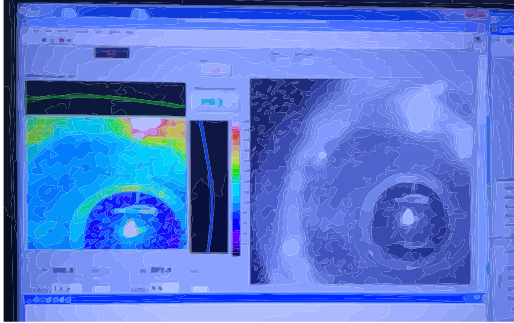


**Fig.13.** Electron beam distribution in horizontal direction at the collimator entrance position

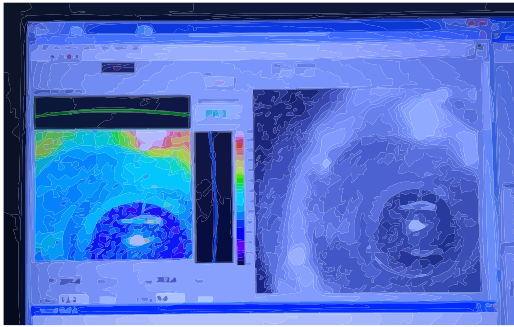
### 3.3. BEAM PHASING AND FOCUSING IN ACCELERATING SECTIONS A1-A9

To provide 100 MeV electron beam energy the stable mode of modulators M1-M6 HV were determined. The final electron beam tuning was done with use of LLRF phasing. At first, the stable mode of beam phasing was chosen to get 100 MeV beam energy using TB1 excitation curve, maximizing FCT5 readings. The final energy adjustment was done with use of LSM2 monitor, putting electron beam at the

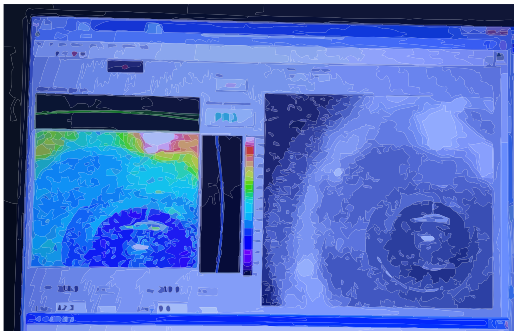
central monitor strips with TB1 exiting current of 499 A that corresponds to 100 MeV electron beam energy. The phasing optimization was continued until beam current reading of FCT3 and FCT5 were about equal that means “0” losses along accelerator and TB1 bending. The beam current pulse at FCT4 and FCT 5 should be rectangular.



**Fig.14.** Electron beam position at PR3 screen with all Q6-Q10 are switched off



**Fig.15.** Electron beam position at PR3 screen with Q6, Q8 are switched on but Q9 and Q10 are off



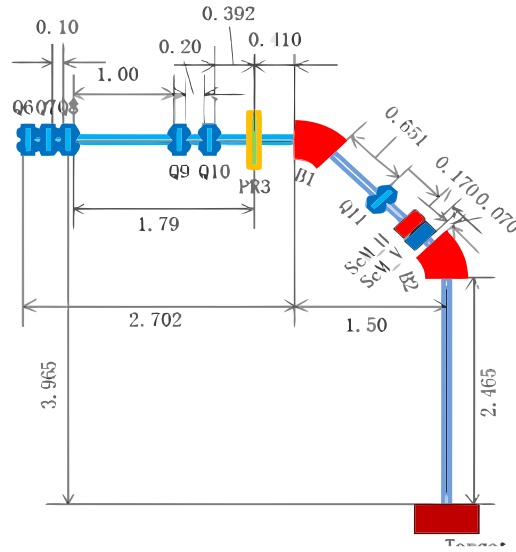
**Fig.16.** Electron beam position at PR3 screen with Q6-Q10 are switched on

### 3.4. BEAM TRANSPORTATION TO THE TARGET

IHEP layout of the transportation channel from the linac exit to target is shown in Fig.17 [6]. Both quadrupole triplet Q6-Q7-Q8 and doublet Q9-Q10 were used to form the electron beam size on the neutron generating target.

To provide required beam focusing the analysis of the beam dynamics in channel lattice was done. The analysis showed serious sensitivity of both beam position and size to the alignment errors of the channel

magnetic elements [7]. The reason of the effect is the high gradients of the quadrupole lenses of both final triplet and doublet.

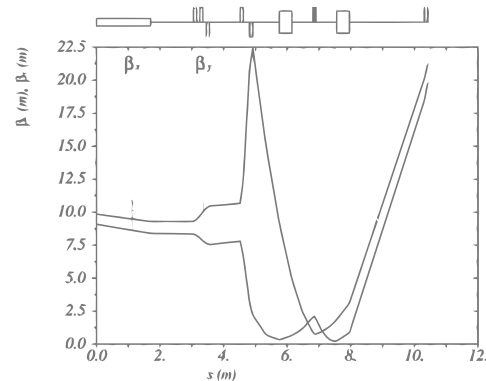


**Fig.17.** Layout of the transportation channel

We redesigned the original lattice project to decrease the focusing strength that allows to focus electron beam at the neutron-generating target in 3x3 mm×mm spot. As a result, new channel lattice is much less sensitive to the element alignment errors. This mode was used during last electron beam tuning experiments. The beam tuning is performed by two doublets Q6, Q8, and Q9, Q10. Quadrupole lens Q7 is switched off. Quadrupole strengths of both lenses of doublets are identical that allows quite easy channel tuning:

- $KQ6 = -KQ8 = 1.3622 \text{ m}^{-2}$ ;
- $KQ9 = -KQ10 = 15.5424 \text{ m}^{-2}$ .

The Twiss lattice functions for this operation mode are shown in Fig.18.



**Fig.18.** Amplitude functions under double doublets focusing

Several neutron flux measurement sessions were carried out. As a result, it was found that the output flange of the TB2 vacuum chamber and its bellows were irradiated. That meant that electron beam was not transported in proper way and hit the walls of

vacuum chamber. Unfortunately, the geometry of the beam transportation channel and radiation conditions in accelerator high power operation do not allow to equip accelerator with regular beam instrumentation device for the beam position monitoring. To provide such possibility and to found stable beam transportation and focusing mode it was decided to replace tungsten target with lead target dummy that will be equipped with two additional lame monitors in X and Y directions respectively. In addition, lead target was connected to the oscilloscope to observe electron beam current. Each lame monitor consisted of 5...6.5 mm width aluminum foil ribbon of 30  $\mu\text{m}$  thickness (Fig.19).

Before start of the accelerator tuning all magnetic element alignments were checked and it was confirmed that accuracies of the element installation are better than 200  $\mu\text{m}$ , that should provide proper beam transportation.

The first experiments on beam transportation showed that beam can be put to the center of the target dummy with differ from each other TB1 and TB2 excitation current. In particular, for the design beam energy of 100 MeV, the TB1 excitation current was 493 A (design value) but the current of TB2 was 508 A.

The magnetic field of TB1-TB2 magnets was measured with the same current of the power supply of 500 A with simultaneous independent measurement of DC supply current. The results of measurements were identical. Each magnet produced the magnetic field value of 0.64 T that corresponds to the original design. It confirms that TB1 and TB2 dipole magnets have different effective length and, the only way to transport electron beam properly is to take into account that experimental fact during beam transportation.

Using the results described above, proper focusing, phasing and beam position correction for the stable mode of the electron beam parameters was realized with electron beam sizes of about  $(3 \times 3) \text{ mm}^2$ . Fig.20 shows the lead target lame strip monitor signal. The operation of all beam instrumentation units of 100 MeV/100 kW electron linear accelerator were provided to support monitoring and adjustment of the electron beam parameters. During accelerator tuning were used 3 scintillating screen monitor (PSR1-PSR3), 2 lame screen monitors (LSM1-LSM2), 5 fast current transformers (FCT1-FCT5), 8 beam position monitors (BPM0-BPM7) (see Fig.5).

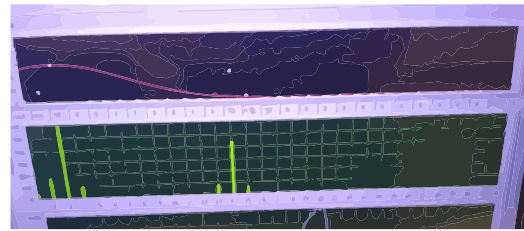
After beam tuning and determination of stable accelerator mode the lead target dummy was removed and the tungsten neutron generation target was installed. After vacuum evacuation the vacuum value in the transportation channel is about  $8 \times 10^{-9}$  Torr.

Further several neutron flux measurement sessions showed good stability and repeatability. The typical beam position measurement results at BPM1-BPM7 were:

|       | BPM0 | BPM1 | BPM2 | BPM3 |
|-------|------|------|------|------|
| X, mm | +6.2 | -0.3 | +0.4 | +2.5 |
| Y, mm | -5.4 | +0.4 | -1.7 | -0.4 |
|       | BPM4 | BPM5 | BPM6 | BPM7 |
| X, mm | +3.5 | +1.0 | +3.0 | +0.3 |
| Y, mm | +3.8 | -0.2 | +0.3 | -0.6 |



**Fig.19.** Lame strip monitors of lead dummy target



**Fig.20.** Signals of lame monitors at lead dummy target



**Fig.21.** Typical neutron flux azimuthal distribution

All mentioned above allows to claim that 100 MeV/100 kW electron linear accelerator has stable, adjusted mode that satisfied to the physical start up requirements of SCA Neutron Source. The represented accelerator tuning provides the stable symmetrical neutron flux distribution (Fig.21).

## CONCLUSIONS

After accelerator system adjustments and beam parameters tuning one can conclude that 100 MeV/100 kW electron linear accelerator meets the SCA Neutron Source physical start-up requirements:

Electron beam energy is 100 MeV;

Energy spread is  $\pm 3\%$ ;

Pulse repetition rate is 20 Hz;

Beam size at neutron generating target is  $\sim 3$  mm;

Pulse beam current is 35 mA.

## References

1. O. Bezditko et al. NSC KIPT Neutron Source on the base of Subcritical Assembly Driven with Electron Linear Accelerator // *Proc. Of IPAC'2013*, 12-17 May, 2013, Shanghai, China, THPFI080, p.3481-3483, <http://www.JACoW.org>.
2. A. Zelinsky et al. NSC KIPT Neutron Source on the Base of Subcritical Assembly With Electron Linear Accelerator Driver // *Proc. Of IPAC'2017*, 14-19 May, 2017, Copenhagen, Denmark, TUPIK034, p.1754-1756, <http://www.JACoW.org>.
3. Yunlong Chi et al. Beam dynamics studies on the 100 MeV/100 kW electron linear accelerator for NSC KIPT neutron source // *Proc. Of IPAC'2011*, 4-9 September, 2011, San Sebastian, Spain, MOPS033, p.673-675, <http://www.JACoW.org>.
4. Yunlong Chi et al. 100 MeV/100 kW Electron Linear accelerator driver of the NSC KIPT Neutron Source // *Proc. Of IPAC'2013*, 12-17 May, 2013, Shanghai, China, THOAB203, p.3121-3123, <http://www.JACoW.org>.
5. O.E. Andreev et al. Test and Commissioning Results of NSC KIPT 100 MeV/ 100 kW Electron Linear Accelerator, Subcritical Neutron Source Driver // *Proc. Of IPAC'2017*, 14-19 May, 2017, Copenhagen, Denmark, TUPIK033, p.1751-1753, <http://www.JACoW.org>.
6. A. Zelinsky et al. Proposals for electron beam transportation channel to provide homogenous beam density distribution at a target surface // *Proc. Of IPAC'2011*, 4-9 September, 2011, San Sebastian, Spain, TUPCO39, p.1084-1086, <http://www.JACoW.org>.
7. P. Gladkikh, A. Kalamayko, A. Zelinsky. Effect of Magnetic Element Alignment Errors on Electron Beam Dynamics in the Transportation Channel of the NSC KIPT Neutron Source Driven With Linear Accelerator // *Proc. Of IPAC'2017*, 14-19 May, 2017, Copenhagen, Denmark, MOPIK107, p.784-787, <http://www.JACoW.org>.

## ПОДГОТОВКА 100 МэВ/100 кВт УСКОРИТЕЛЯ ДЛЯ ФИЗИЧЕСКОГО ЗАПУСКА ИСТОЧНИКА НЕЙТРОНОВ ННЦ ХФТИ

*А. П. Бездетко, А. Н. Гордиенко, П. И. Гладких, А. М. Гвоздь, Д. А. Каплій, И. М. Карнаузов, И. И. Карнаузов, В. Н. Лященко, А. О. Мыцыков, М. П. Моисеенко, В. Е. Руденко, А. В. Резаев, Д. В. Тарасов, В. И. Троценко, А. Ю. Зелинский*

Источник нейтронов ННЦ ХФТИ использует 100 МэВ/100 кВт электронный линейный ускоритель как драйвер для генерации первичных нейтронов. В июле 2018 года индивидуальные испытания технологических систем ускорителя были успешно проведены, и осенью 2018 года была начата опытная эксплуатация ускорителя. С того времени было сделано следующее: подготовлены и проведены государственные комплексные испытания подкритической установки – источника нейтронов ННЦ ХФТИ, налажено и улучшено функционирование технологических систем ускорителя, оптимизированы параметры электронного пучка, ускоритель был подготовлен для проведения физического запуска. Наиболее важные результаты опытной эксплуатации ускорителя и методы улучшения работы технологических систем ускорителя представлены в статье.

## НАЛАШТУВАННЯ 100 МеВ/100 кВт ПРИСКОРЮВАЧА ДЛЯ ФІЗИЧНОГО ПУСКУ ДЖЕРЕЛА НЕЙТРОНІВ ННЦ ХФТІ

*О. П. Бездітко, А. М. Гордиенко, П. І. Гладких, А. М. Гвоздь, Д. О. Каплій, І. М. Карнаузов, І. І. Карнаузов, В. М. Лященко, А. О. Мициков, М. П. Моїсеєнко, В. Є. Руденко, О. В. Резаев, Д. В. Тарасов, В. І. Троценко, А. Ю. Зелінський*

Джерело нейтронів ННЦ ХФТІ використовує 100 МеВ/100 кВт електронний лінійний прискорювач як драйвер для генерації первинних нейтронів. У липні 2018 року індивідуальні випробування технологічних систем прискорювача були успішно проведені, і восени 2018 року було почато експериментальну експлуатацію прискорювача. З того часу було зроблено наступне: підготовлені та проведені державні комплексні випробування підкритичної установки – джерела нейтронів ННЦ ХФТІ, налагоджено та поліпшено функціонування технологічних систем прискорювача, оптимізовано параметри електронного пучка, прискорювач було підготовлено для проведення фізичного пуску. Найважливіші результати експериментальної експлуатації прискорювача та методи поліпшення роботи технологічних систем прискорювача представлено у статті.