

MULTIPASS BREMSSTRAHLUNG TARGETS FOR ULTRA-HIGH-POWER PULSED ELECTRON BEAMS

V. Chorny

Kharkiv State University, Kharkiv, Ukraine

Search for a better upgrading of bremsstrahlung target converters for high-power electron beam pulses brought home the idea of placing a thin metallic target in the magnetic field in such a way as to have its lines of force directed at an acute angle towards the target surface [1]. The placing of the bremsstrahlung target in a sufficiently strong magnetic field provides two obvious advantages as compared with the standard target:

1. The magnetic field can provide for a multiple electron passes through the bremsstrahlung foil, with reflecting electrons, usually lost in the standard target, being returned by the field to the target to participate in the further processes of bremsstrahlung X-ray radiation (BXR) generation.

2. Multiple electron passing through the bremsstrahlung target allows to make it infinitely thinner than the optimum standard one for single-pass action (in this case, its optimum thickness is about one-third of the electron travel length into the target substance), with the low-energy BXR yield increasing dramatically without decreasing the total beam radiation losses.

In order to translate this idea into life in a real device a proposal was made to make use of the electron gradient drift in such an azimuthal magnetic field as created by the linear current in the conductor [2]. Schematic of the proposed device is given in Fig.1.

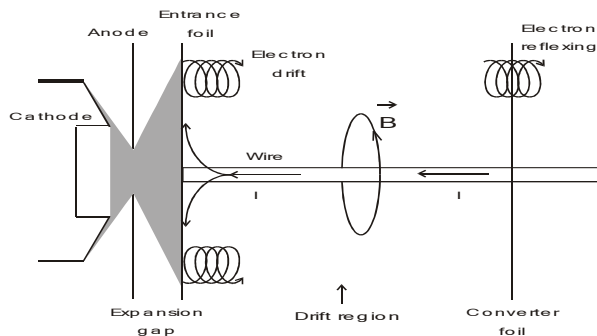

Fig. 1

The electron beam generated in the pinching vacuum diode passes through the output window in the center of the anode, being able to expand behind the anode. Afterwards, the electrons move into the drift region where the axis-positioned current-carrying conductor generates the azimuthal magnetic field. The Larmore radii do not close due to the field gradient, creating a drift along the conductor. Neutralization of beam charge and current is provided by the low-pressure gas in the beam expansion and drift regions. The electron drift motion ensures multiple beam passes through the foil. The mean number of electron penetrations through the foil n can be gathered from the

following relationship: $n = 3I_{cond}/I_A$, where I_{cond} is the conductor-carried current which excites the magnetic field, I_A is the Alfvén current which is equal to $17\beta\gamma$ kA.

Experimental research on high-current electron beam transport in the azimuthal magnetic field and beam-generated BXR was carried out simultaneously at Kurchatov Institute in Moscow and Kharkiv State University (KhSU) [3, 4], with KhSU [5] being the only one to bring this research to a real applied technical solution. Of paramount importance in the structure of the thus-produced target device is the fact that the target tantalum foil is placed in position not perpendicular to the beam axis, but at an angle close to 45° (See Fig. 2).

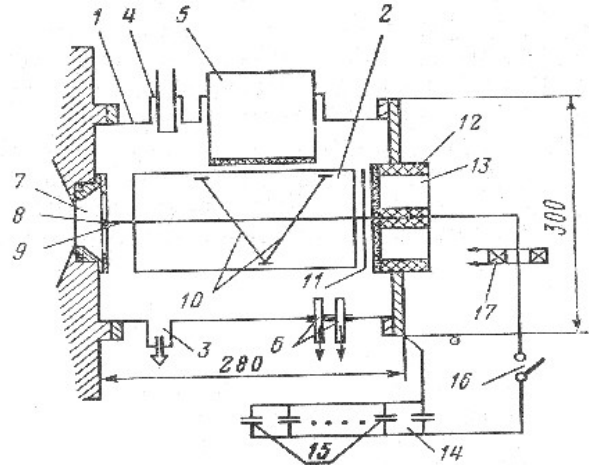

Fig. 2. Schematic drawing of the converter

1 – drift chamber; 2 – window for diagnostics; 3 – pipe for pumping out gas; 4 – vacuum valve fixing unit; 5 – travelling cup with a window for BRX ejection; 6 – pipes for pumping out and filling in gas; 7 – anode unit; 8 – place of central conductor fixing; 9 – central conductor; 10, 11 – converter foils; 12 – vacuum current lead-in; 13 – holes for BRX ejection; 14 – magnetic field generator; 15 – capacitor bank; 16 – ignitron; 17 – Rogowski coil.

Such a target set-up allows to extract radiation perpendicular to the beam direction, thereby eliminating the need in the beam absorber which also acts to decrease the low-energy BXR yield. This target set-up allows for installation of two and more (V-like) metallic foils of small thickness, thereby forming the radiation field of a needed area coverage and homogeneity. In this target device the produced dose per kJ of the beam, 21 cm away from the converter foil, made 15 kRad (CaF₂) as compared with 2.15 kRad produced in an analogous device [2].

The conversion efficiency of electric energy, fed to the accelerator diode, into BXR in the upgraded target device depends on the right structural solution and perfect match-up of operation modes throughout the entire system: from the diode to the output window through which radiation is extracted. The modified target device, as different from the standard one, has the BXR generation location placed outside of the high-current diode, as a matter of fact, it may be positioned at a considerable distance off. For this reason, those devices are very attractive for employment in such modular configurations in which one has to converge several beams of the total incident pulsed power of ≥ 10 W onto the common target.

A new start in research progress on the upgraded converter was given by participation of Kharkiv State University in the Defense Threat Reduction Agency (DTRA) project (USA) on modular X-ray generator DECADE. In its final version, DECADE must consist of 16 accelerator modules, with each one contributing 2 MJ in beam energy on to the common target with the electron kinetic energy 1.7-2.0 MeV.

As dedicated research for this project, Kharkiv State University designed, fabricated and tested a novel target device on GAMBLE-II accelerator in Naval Research Laboratory (NRL) in the USA that has a MA current diode.

In order to achieve the maximum beam injection efficiency into the target chamber and beam capture by the azimuthal magnetic field, we opted for a triaxial diode configuration providing the circular pinch. Transition from the coaxial accelerator output to the triaxial diode is provided by self-magnetic insulation made as “rod-through-grounded hole” (convolute) junction. To broaden the energy range of electrons, drift-trapped by the magnetic field, and somewhat compress the beam diameter (its initial diameter is 140 mm), a magnetic field fluctuation (magnetic mirror) is used that has a custom-designed surface shape. The above magnetic field fluctuation is created through utilization of such a conductor system that provides for current pulse splitting in the axial conductor. The BXR extraction window is made of mylar and 100 μ m thick. Before installing the device on Gamble-II, it had been tested on Nadiya accelerator at Kharkiv State University (1MV, 100kA). In order to match the diode to the accelerator output impedance (7 Ohm) the cathode was replaced by three rods that had blades at their extremities. Such approach provided for good self-insulation of the convolute junction, and the diode was now capable of generating three beams, carrying 35 kA

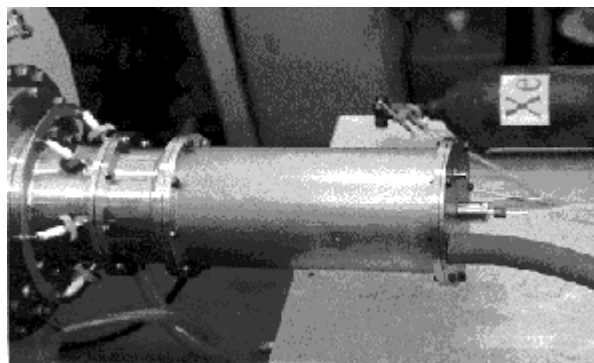

each. Exterior view of the device on this accelerator is shown in Fig. 3.

Fig. 3

To facilitate the target device tune-up and simulations of the BXR generator performances on different accelerators, we developed a software package which simulates the target device operation from A to Z, beginning when electrons traverse the diode output window to X-ray dose distribution downstream of the target chamber output window. Fig. 4 gives the computer-modeled graphic representation of the device.

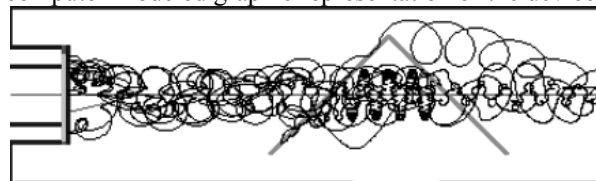

Fig. 4

The target device experimental testing at Kharkiv State University indicated that its beam performance corresponds to the model input data. Fig. 5 shows X-rayed images of device characteristic operation.

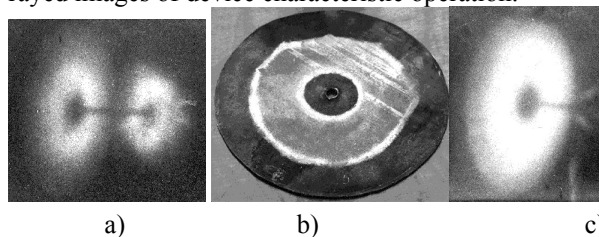

Fig. 5

- a) image of the lead target made in X-rays;
- b) the beam trace on the target;
- c) V-like target in X-rays: to the right – 30 μ m thick Ta, to the left – 1 mm thick Pb. The beam direction is to the right.

Device tested performance on Gamble-II at NRL came out with a high diode parameter pulse-to-pulse reproducibility, as well as that of the entire device, with the diode impedance being about 2 Ohm. The custom calorimetric measurements indicated that during the delivered pulse interval, when the diode voltage exceeds

300 kV, virtually, all of the electric energy, fed to the diode, is transported in the electron beam to the target at a distance 30 cm off from the anode.

Fig. 6 shows the results of the dose measurement run on the output window, using TLD-dosimeters and computer simulations-related calculations with introduced I-V oscillogram readings on the diode for pulse # 2029.

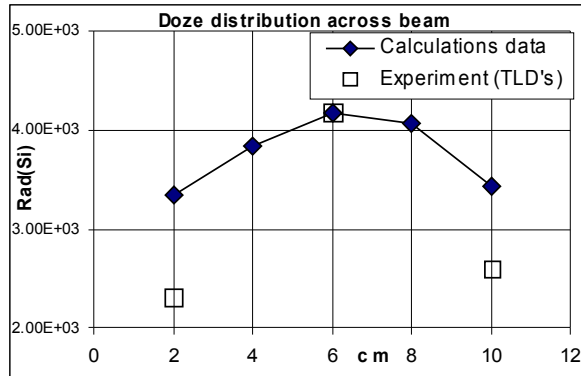

Fig. 6

Successful employment of the gradient drift for high-efficiency conversion of high-current beams into BXR prompted the idea of using heavy gases (Xe) instead of the metallic foils. In this case, a lengthy BXR volume source with efficiently controllable parameters is formed in which the electron energy radiation conversion efficiency is comparable to that with tantalum converters. In this device, the drift chamber is filled with xenon at the pressure 100 to 700 Torr. Owing to the electron drift motion through this gas, an enhanced beam energy yield is produced per gas volume unit. By varying current in the axial conductor and gas density, one can vary the source dimensions across a wide scope. The produced X-ray radiation is extracted through thin walls of the chamber.

Fig. 7 shows the X-rayed image of this source, and Fig. 8 - the BXR dose distribution along the drift chamber wall vs gas density.



Fig. 7. Image of the Xe target made in X-rays at various currents of the central conductor.

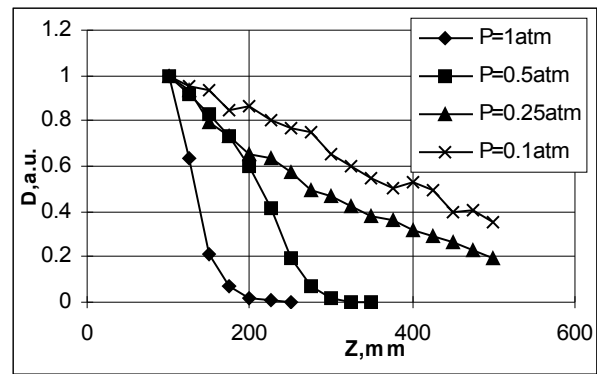

Fig. 8. Dose distribution along the chamber axis at various Xe density.

Gas targets can be very useful for generation of an intense characteristic K_{α} -radiation. In this case, lighter gases are used, for instance, argon ($\lambda_{K_{\alpha}} = 0.48$ nm) from which bremsstrahlung radiation yield is decreased considerably. In the process, as electron energies decrease during electron propagation through the gas, the relation of bremsstrahlung X-ray yield vs. fluorescent X-ray yield is swiftly changed in favor of the latter. An experiment conducted in 1991, on K_{α} -radiation generation in Ar [6] produced over 50% fluorescent radiation from the total output spectrum.

Thus, one can summarize that a novel generation of target devices comes increasingly into play on the technological arena of ultra-high-power short-pulse X-ray generation.

REFERENCES

- [1] J. A. Halbleib Sr., J. Appl. Phys. **45**, 9, 4103-4109 (1974).
- [2] James R. Lee, Robert. C. Backstrom, John. A. Halbleib, Jeffrey P. Quintenz, and Thomas P. Wright, J. Appl. Phys. **56**, 11, 3175-3181 (1984).
- [3] K. A. Bajgarin, V. F. Zinchenko, M. N. Lebedev, N. U. Barinov. Transportirovka sil'notochnogo REP v gaze vdol' provodnika s tokom i generaciya tormoznogo izlucheniya, Preprint of Kurchatov Institute in Moscow (1989).
- [4] V. Chorny, O. Morgun, S. Magaram, E. Domanov, Atomnaya Energiya (Sov.) **68**, 4, 254-257 (1990).
- [5] E. Domanov, O. Morgun, V. Chorny, Pribory i Tekhnika Eksperimenta (Sov.) **2**, 43-45 (1991).
- [6] A. Dunaevsky, A. Lomako, Yu. Kresnin, O. Morgun, V. Chorny, Pis'ma v JTF (Sov.) **18**, 16, 83-86 (1992)