

Efficient silencers with spherical baffles were developed for 5.45 mm – 9.0 mm small arms. The most promising silencers of this type are those with:

- peripheral labyrinth vortex gas withdrawal circuit;
- additional expansion chamber that embraces the outside part of the barrel and is connected gas-dynamically to a traditional muzzle silencer, which extends beyond the muzzle end.

Silencers with deformable elastic structural components made by the traditional scheme – movable flat baffles loaded by coil compression springs – were developed and tried out too.

1995
5,45 – 9,0
[13].
2013 – 2018
[14 – 17].
[1 – 12].

5,56 , 7,62 9,0 . 5,45 ;

: , , , , ,

[4]. (. 1)

- 7,62 - Blaser, Browning Bar, SAKO, Manlicher, - ;
- 5,45 , 5,56 - -74 , -74,
- 16, Blaser, M4A1, SAKO, .
- 5,45 - -11 .12-5,45;
- 7,62 - -19 .12-7,62.

ASE Ultra SL7-7,62, (. 1).

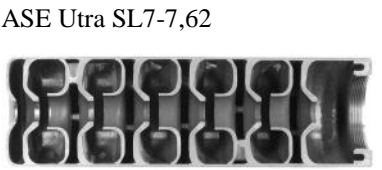
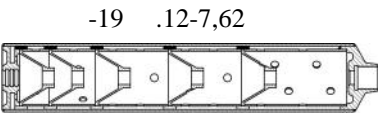
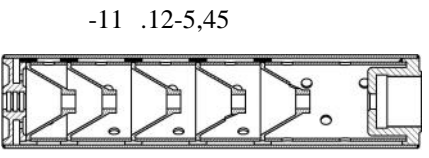

. 1 -

ASE Ultra SL7-7,62

1

15 %

1 -

	-19 .12-7,62	-11 .12-5,45	ASE Ultra SL7-7,62
	7,62	5,45 , 5,56	.308 Win .338 Lapua Mag
	44	44	45
	238	195	166
	14x1; 15x1; 16x1; 18x1; 9/16"-24; 14x1 ()	24x1,5; 18x1; 1/2"-284; 1/2'-20 14x1 ()	24x1,5; 18x1; 1/2"-284; 1/2'-20 14x1 (-)
	(-)	(-)	-
	435 (750)	400 (690)	800
	32 36	28 32	32 35

: -

- « ».

[1 - 13].

(. 2),
1:1,41:2,0, . . .

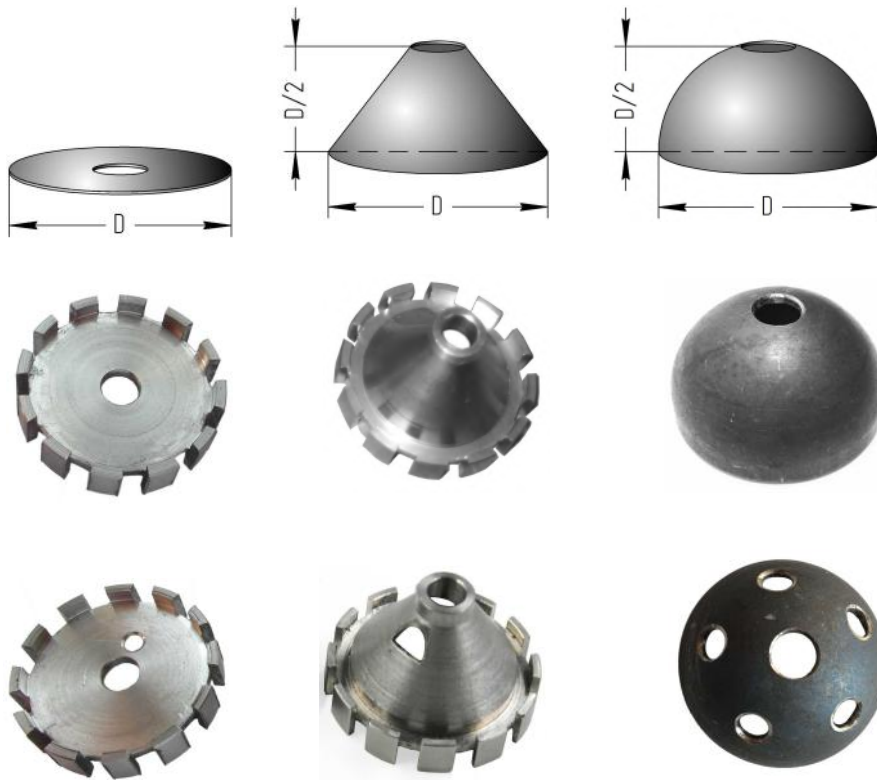

)
 D- ;)- ;)-
)-
 .2-

[2, 3, 7, 8, 11, 12].

7,62 3-

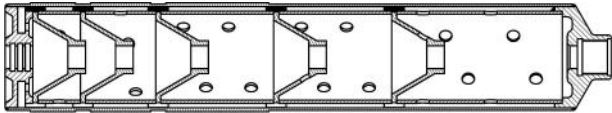
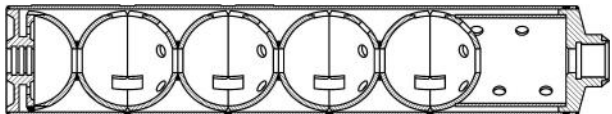
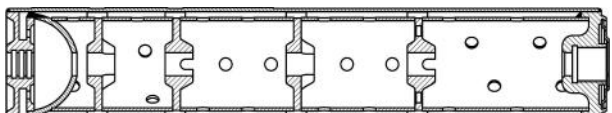
19 .12-7,62		Ø44,0×241,475
02 .15(2)-7,62		Ø44,0×239,470
09 .17-7,62		Ø44,0×239,407

Koch 9×19 1000 MP5, Heckler & Koch
MP5

MP5 - MKM-091 - 9×21

MP5.
-05 .18-9,0 MP5 KA1/KA5
9,0 Heckler & Koch;
-05 .18-9,0 -04 .18-9,0
MP5 A2/A4 9,0 Heckler & Koch.

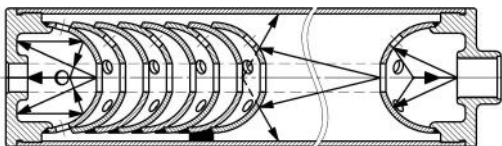

.3-
05 .18-9,0 9,0 -05 .18-
.3.

.4

4-

5

	$\text{Ø}50 \times 200$; 450 ; 28
	$\text{Ø}50 \times 375$; 500 ; 34
	$\text{Ø}50 \times 309$; 520 ; 30

*

- 15x1

.5

5-

	17 33	28 34
2	$\text{Ø}35 \times 226$ $\text{Ø}51 \times 338$	$\text{Ø}50 \times 200$ $\text{Ø}50 \times 375$

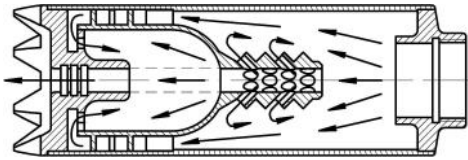

.4 -

.6

Serefire.

	Mini Monster	-01 .14-5,45
	5,56	5,45
	400	299
	38	45
	133	130
	134	132

[12].

(.5).

1
6

3.

4

5.

Savage Arms Rem.233,
CZ 525,
50

MR223, O CB ,Blaser R93,
7,62, Mauser 98, Heckler&Koch MR .338,
C.T.S.M.338 C.T.S.M.308 ..

32 36 .

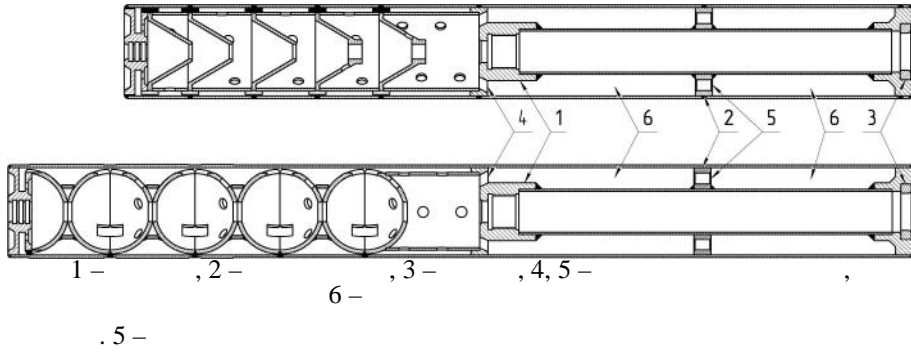

Reflex Suppressors () -

[16].

[5].

.6

[5]

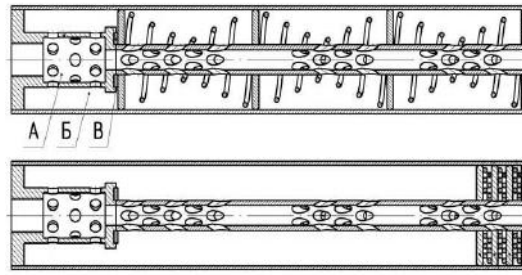

. 6 -

. 7, 8

22 .13-9,0,

. 7

-22 .13-5,6



. 7 - -22 .13-5,6

. 8 - -22 .13-9,0

7 -

	-22 .13-5,6	-22 .13-9,0
,	5,6	9,0
,	25	25
,	200	200
	14×1 , 1/2-20	12×1
	,	,
,	140	140
,	5,6	9,0
	5,6 , Savage 64, Savage 93	

[10],

5,6 , ,

MAE Kilwell Whisper .22LR.

9

9,0 :

