

Varetsky Y.<sup>1,2\*</sup>, Hanzelka Z.<sup>1</sup>

<sup>1</sup>- AGH-University of Science & Technology,  
al. Mickiewicza 30, 30-059, Krakow, Poland,

e-mail: [hanzel@agh.edu.pl](mailto:hanzel@agh.edu.pl)

<sup>2</sup>- Lviv Polytechnic National University,  
Bandera str. 12, Lviv, 79013, Ukraine,

e-mail: [j.varetsky@gmail.com](mailto:j.varetsky@gmail.com)

*This paper discusses the issue of modelling a hybrid renewable energy system for a micro-grid connected to a bulk power system. The objective of the work is to create a tool for assessing the feasibility of an energy hybrid system operation with an appropriate control strategy to ensure its efficiency. A hybrid of a solar, a wind and an energy storage device was examined. The integrated model uses statistical indices of solar irradiation and wind speed data to simulate power flow in the system. As the microgrid load demand is variable, power interchange with the bulk power system is managed by a power system supervisor. The control strategy and the load profile of the microgrid must be used to estimate the correct size of the hybrid system storage system. The proposed model was subjected to a case study. References 9, figures 8.*

**Key words:** Modelling, microgrid, hybrid energy system.

**1. Introduction.** Environmental concerns and limited reserves of natural energy resources have resulted in ever increasing use of renewable energy sources. Wind turbine (WT) and photovoltaic (PV) generators are used all over the world to supply customers in remote areas. However, use of a single form of primary energy (e.g. solar or wind) may, due to the stochastic nature of these sources, result in periods when no or low electricity is generated, meaning that it will not be possible to supply electricity at such times. Yet if more than one renewable source is used for energy generation, for example a combination of WT and PV generators, energy generation will be less dependent on one intermittent energy source. To make the system more stable, an energy storage device (SD) must be included to accumulate energy during excess WT and PV generation and to supply energy during deep falls in generation. Combining energy sources and storage devices into one system is commonly known as a hybrid renewable energy system. Such a combination of energy units considerably improves supply security; hybrid systems in remote areas, for example, may function as a support system for grid-connected consumers and could increase supply efficiency. However, the high overall cost of hybrid systems with respect to its duty factor is a concern when they are used widely. To counter this, it is possible to minimize the total cost of electricity supply in a selected area when considering the power system dispatch requirements through correct hybrid renewable energy configuration sizing.

Several authors have studied the problem of operating and optimal sizing of hybrid renewable energy systems [3, 5–9]. The aim of this paper is to present a model of hybrid energy generation system connected to the public grid. The model is based on mathematical modelling of the energy response of each hybrid component and stochastic modelling of primary energy sources.

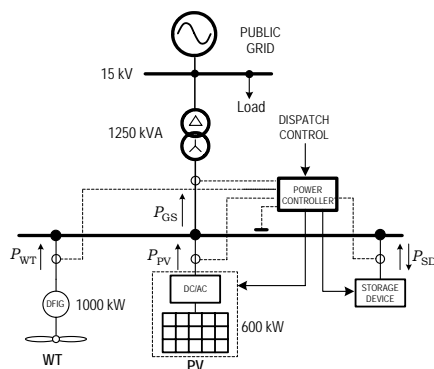

Fig. 1

**2. Description of the hybrid system.** The hybrid renewable WT/PV/SD system outline is presented in Fig. 1. The diagram shows the basic components along with the functional connections between them. All components of the WT/PV/SD system are connected to a 15 kV public grid bus through a 1250 kVA step-up transformer. A local load is connected to the same 15 kV bus to ensure a continuous supply. A 1000 kW Doubly-Fed Induction Generator (DFIG) is used in the WT unit. The DFIG's mechanical and electrical controls ensure the maximum electrical power input at corresponding wind speeds according to the WT power curve provided by its manufacturer. The photovoltaic

generator consists of photovoltaic panels which have, according to standard test conditions, an aggregate capacity of 600 kW. The photovoltaic generator is connected to the AC bus through a DC/AC inverter. The photovoltaic generator is equipped with a control system that ensures sinusoidal input voltage and generator operation at the Maximum Power Point (MPP) [7] for all solar radiations.

The storage device in the tested hybrid system is the component to be selected. In general, choice of a storage device depends on the operational characteristics and pricing of the hybrid system [3–5,7].

### 3. Stochastic modelling of the hybrid system

*A. Wind turbine.* The output power from the wind turbine can be obtained by using a wind turbine power curve. The tested wind turbine power curve provided by the manufacturer in relation to turbine power controls is shown in Fig. 2.

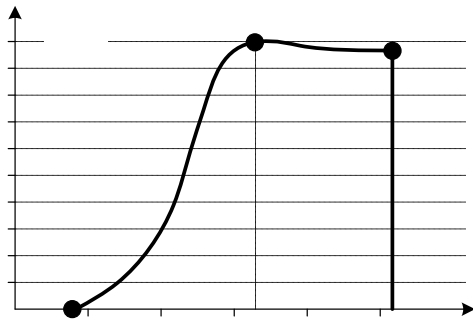

Fig. 2

The statistic parameters of the wind speed can be estimated by using a probability distribution function for a specific site [1, 2]. Weibull probability density function (pdf) is used to describe wind speed variation:

$$f_V = \frac{k}{c} \left(\frac{V}{c}\right)^{k-1} \exp\left(-\left(\frac{V}{c}\right)^k\right), \quad (1)$$

where  $V$  – wind speed;  $k = (\sigma_V / \mu_V)^{-1.086}$  – shape factor;

$c = \frac{\mu_V}{\Gamma(1+k^{-1})}$  – scaling factor;  $\mu_V$  – mean wind speed;

$\sigma_V$  – standard deviation of the wind speed probability function;  $\Gamma$  – Gamma function.

The following values were obtained through analysing the wind characteristic measurements of the relevant area:  $\mu_V = 5.9$  m/s and  $\sigma_V = 3.6$  m/s. The Weibull functions for the probability density  $f_V$  and relevant cumulative distribution  $F_V$  calculated by the wind speed statistic parameters are presented in Fig. 3.

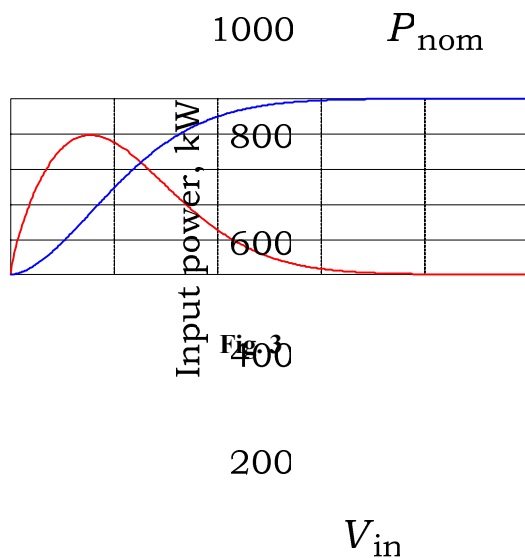

Fig. 3

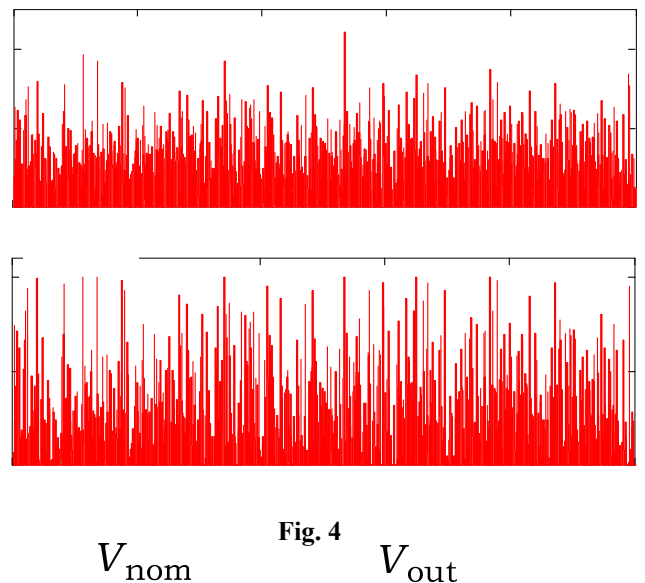

Fig. 4

On the basis of the wind statistic parameters, pseudorandom wind functions for the investigated time period can be obtained using Weibull random number generator software. In order to apply stochastic modelling of the WT power input, the approximation of the WT power curve (see Fig. 2) was achieved using the following formulas:

$$P_{WT} = \begin{cases} P_{nom} \cdot \frac{V^{1.8} - V_{in}^{1.8}}{V_{nom}^{1.8} - V_{in}^{1.8}} & \text{if } V_{in} \leq V < V_{nom} \\ P_{nom} & \text{if } V_{nom} \leq V < V_{out} \\ 0 & \text{if } V_{in} > V \text{ or } V \geq V_{out} \end{cases} \quad (2)$$

The pseudorandom wind and appropriate power input as time functions for the examined area and WT ratings ( $P_{nom}=1000$  kW,  $V_{nom} = 16$  m/s) are shown in Fig. 4. The simulation was carried out using 15-minute wind speed data averaging.

**B. Photovoltaic Generator.** PV generator performance is considered in the model by the maximum power output at different PV module temperatures and various irradiation levels. This model makes it possible to obtain PV generator output power at various climatic conditions at a specific site. The output power of a PV panel can be calculated using the following equations:

$$P_{PV} = N \cdot U_{mp} \cdot I_{mp}, \quad (3)$$

where 
$$U_{mp} = U_{mpp} + K_V \cdot (T - T_s), \quad I_{mp} = I_{mpp} + I_{SC} \cdot G \cdot G_s^{-1} + K_I \cdot (T - T_s) \quad (4,5)$$

In these equations:  $T$ ,  $G$  – current temperature and irradiation level;  $N$  – number of cells in the panel;  $U_{mpp}$ ,  $I_{mpp}$ ,  $K_V$ ,  $K_I$ ,  $I_{SC}$ ,  $G_s$ ,  $T_s$  – specific data of the photovoltaic cell [4,9].

As is known from field measurements [1], solar irradiation over a long time period can be approximated by a  $\beta$  probability density function:

$$f_G = \frac{\Gamma(\alpha + \beta)}{\Gamma(\alpha)\Gamma(\beta)} \left(\frac{G}{G_{max}}\right)^{\alpha-1} \left(1 - \frac{G}{G_{max}}\right)^{\beta-1}, \quad (6)$$

where  $G_{max}$  – maximum irradiation for the time period in the explored area.

Parameters of the probability density function are calculated by the following formulas:

$$\alpha = \mu_G \left[ \frac{\mu_G(1 - \mu_G)}{\sigma_G} - 1 \right]; \quad \beta = (1 - \mu_G) \left[ \frac{\mu_G(1 - \mu_G)}{\sigma_G} - 1 \right],$$

where  $\mu_G$  – mean irradiation;  $\sigma_G$  – standard deviation of the irradiation probability function.

For the analysed area, solar irradiation is characterized by the following quantities:  $\mu_G = 172$  W/m<sup>2</sup> and  $\sigma_G = 129$  W/m<sup>2</sup>. The density function  $f_G$  and relevant cumulative distribution function  $F_G$  are presented in Fig. 5. The functions are calculated using solar irradiation statistic parameters. A pseudorandom solar irradiation time function for a considered season can be obtained using solar irradiation statistic parameters through  $\beta$  random number generator software. Having previously calculated the solar irradiation time function and probability ambient temperature time period for the examined area, the PV power model given by (3), (4) and (5) makes it possible to calculate the PV power input considering the specific PV installation data. The pseudorandom solar irradiation and appropriate power input as a time function for the examined area are shown in Fig. 6. The simulations were carried out in relation to 15-minute solar irradiation data averaging.

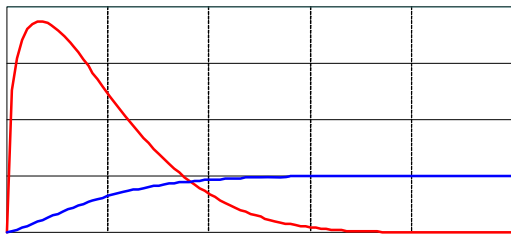

Fig. 5

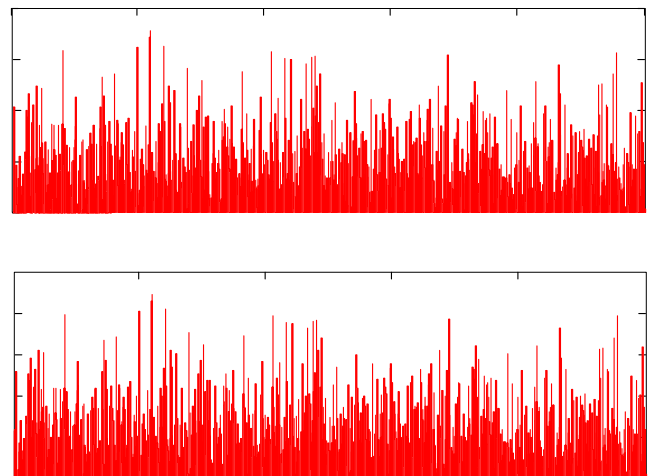

Fig. 6

For short-term predictions (a time period of a day or week) the solar irradiation time function can be better determined through the daily irradiation characteristics of an analysed season.

C. *Generalized energy storage.* Generalized energy storage (SD) is modelled on the basis of the following energy relations:

$$E_{SD}(t) = E_{SD}(t-1)(1 - \nu) + [(P_{WT}(t) + P_{PV}(t) - P_{SR}(t))\Delta t]\eta; \quad E_{SD\min} \leq E_{SD}(t) \leq E_{SD\max} \quad (7)$$

where  $E_{SD}(t)$  i  $E_{SD}(t-1)$  – the SD energy charge at the time  $t$  and  $(t-1)$ ;  $E_{SD\min}$ ,  $E_{SD\max}$  – minimum and maximum permissible levels of the SD charge (kWh);  $P_{SR}(t)$  – current required level of the hybrid system’s output power;  $\Delta t = t - (t-1)$  – time step of power averaging;  $\nu$  – self-discharge rate within time step  $\Delta t$ ;  $\eta$  – SD efficiency.

D. *Simulation example.* The simulation uses the statistic parameters for wind speed variation in the specific site presented above. Pseudo stochastic power output has been generated on the basis of those data and the analysed wind turbine power curve by means of MathCAD software. The assumed solar irradiation characteristics for the examined case study were those of typical sunny day in the summertime. The time step of power averaging in the simulation is equal to 15 minutes. The simulation was carried out for a period of 48 hours. The storage device size ( $E_{SD\max}$ ) was assumed to be 1500 kWh and the minimum permissible level of the SD charge ( $E_{SD\min}$ ) was assumed to be 200 kWh. Fig. 7 presents the power flows in the microgrid components over 48 hours without using the SD under a constant dispatch limit of 800 kW power generation ( $P_{GS}$ ) from the hybrid system into the public grid. For comparison, Fig. 8 presents the power flows in the microgrid components using SD under the same conditions and dispatch limit on the hybrid system power generation. As can be observed from the simulation results in Fig.7, the hybrid system power-generating capability ( $P_{WT} + P_{PV}$ ) cannot be fully exploited in the analysed conditions due to the limiting of the hybrid system power input  $P_{GS}$ . Due to the operation of SD (Fig.8), the power generation  $P_{GS}$  into the public grid is more stable than it is without SD operation.



Fig. 7

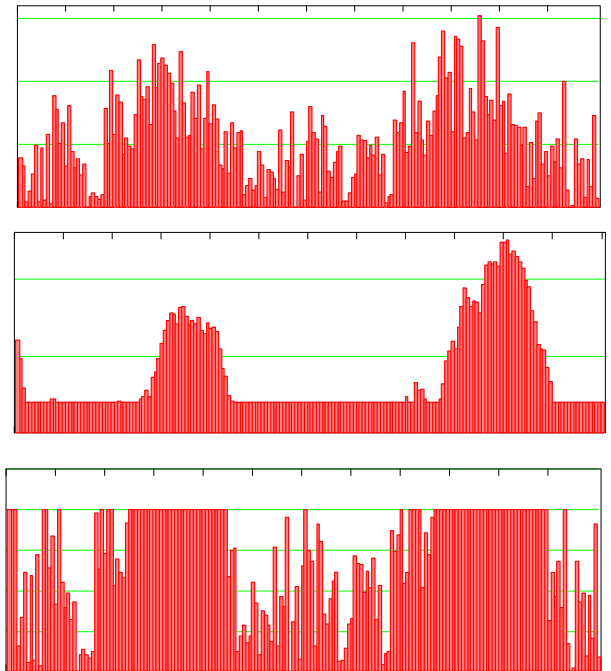

Fig. 8

**4. Conclusion.** This paper provides a model for simulating stochastic power flows within a grid-connected hybrid renewable energy system. The climate characteristics were implemented in the model using its statistic parameters. An example hybrid renewable energy system operation condition was analysed taking into account a power system dispatch limitation. The presented simulation results clearly show that the proposed model can be a useful tool for sizing the components of a hybrid renewable energy system and predicting its energy management in selected sites.

ACKNOWLEDGMENTS.

This work was supported by the AGH University of Science and Technology under the European Regional Development Fund, Subsidy No. POIG.01.03.01-30-056/12.

1. *Alireza S., Morteza A., Mehdi E.* A Probabilistic Modeling of Photo Voltaic Modules and Wind Power Generation Impact on Distribution Networks // IEEE Systems Journal. – 2012. – Vol. 6. – No 2. – Pp. 254–259.
2. *Belu R., Koracin D.* Statistical and Spectral Analysis of Wind Characteristics Relevant to Wind Energy Assessment Using Tower Measurements in Complex Terrain // Journal of Wind Energy, Article ID 739162. – 2013. – Pp. 1–12.
3. *Ekren O., and Ekren B.Y.* Size optimization of a PV/wind hybrid energy conversion system with battery storage using response surface methodology // Applied Energy 85. – 2008. – Pp. 1086–1101.
4. *Maity and Rao S.* Simulation and pricing mechanism analysis of a solar-powered electrical microgrid // IEEE Systems Journal. – 2010. – Vol. 4. – No 3. – Pp. 275–284.
5. *Moriana, San Martín I., Sanchis P.* Wind-photovoltaic hybrid systems design // 2010 Int. Symposium on Power Electronics Electrical Drives Automation and Motion (SPEEDAM). – 2010. – Pp. 610-615.
6. *Nema P., Nema R.K., Rangnekar S.* A current and future state of art development of hybrid energy system using wind and PV-solar. A review // Renewable and Sustainable Energy Reviews, 13. – 2010. – Pp. 2096–2103.
7. *Ozaki Y., Miyatake M., Iwaki D.* Power control of a stand-alone photovoltaic/ wind/ energy storage hybrid generation system with Maximum Power Point Tracker // Int. Conf. on Electrical Machines and Systems (ICEMS), 2010. – Pp.607–611.
8. *Paska J., Biczal P., Kłos M.* Hybrid power systems – An effective way of utilising primary energy sources // Renewable Energy, 34. – 2009. – Pp. 2414–2421
9. *Zhou W., Lou C., Lu L., Yang H.* Current status of research on optimum sizing of stand-alone hybrid solar-wind power generation systems // Applied Energy. – 2010. – Vol.87. – Pp. 380–389.

УДК 621.316.1

## **ВЕРОЯТНОСТНОЕ МОДЕЛИРОВАНИЕ ГИБРИДНОЙ ЭЛЕКТРОСТАНЦИИ С ВОЗОБНОВЛЯЕМЫМИ ИСТОЧНИКАМИ ЭНЕРГИИ**

**Варецкий Ю.<sup>1,2</sup>, Ханзелька З.<sup>1</sup>**

<sup>1</sup>– АГН-Научно-технический университет, ал. А. Мицкевича, 30, 30-059, Краков, Польша,

<sup>2</sup>– Национальный университет Львовская политехника, ул. С. Бандеры, 12, Львов, 79013, Украина

e-mail: j.varetsky@gmail.com, hanzel@agh.edu.pl

*В статье рассмотрены вопросы моделирования гибридной электростанции с возобновляемыми источниками энергии для локальной сети, присоединенной к электроэнергетической системе. Целью работы было создание инструмента для обоснования рабочих характеристик гибридных электростанций с выбранными стратегиями регулирования для обеспечения эффективности их применения. Исследована гибридная установка, содержащая солнечную и ветровую электростанции, а также аккумулятор энергии. Поскольку электропотребление в локальной сети изменяется во времени, обмен мощности с электроэнергетической системой контролируется диспетчером. Поэтому, стратегия регулирования и график потребления в локальной сети должны приниматься во внимание для корректного расчета емкости аккумулятора энергии гибридной электростанции. Показано применение разработанной модели на примере конкретной локальной сети.*

Библ. 9, рис. 8.

**Ключевые слова:** Моделирование, локальная сеть, гибридная электростанция.

## **ЙМОВІРНІСНЕ МОДЕЛЮВАННЯ ГІБРИДНОЇ ЕЛЕКТРОСТАНЦІЇ З ВІДНОВЛЮВАНИМИ ДЖЕРЕЛАМИ ЕНЕРГІЇ**

**Варецький Ю.<sup>1,2</sup>, Ханзелька З.<sup>1</sup>**

<sup>1</sup>– АГН-Науково-технічний університет, ал. А. Міцкевича, 30, 30-059, Краків, Польща,

<sup>2</sup>– Національний університет Львівська політехніка, вул. С.Бандери 12, Львів, 79013, Україна

j.varetsky@gmail.com, hanzel@agh.edu.pl

*В статті розглянуто питання моделювання гібридної электростанції з відновлюваними джерелами енергії для локальної мережі, що приєднана до електроенергетичної системи. Метою роботи є створення засобу обґрунтування робочих характеристик гібридних электростанцій з вибраними стратегіями регулювання для забезпечення ефективності їхнього застосування. Досліджено гібридну установку, що містить сонячну та вітрову электростанції і акумулятор енергії. Оскільки електроспоживання в локальній мережі змінюється з часом, обмін потужності з електроенергетичною системою контролюється диспетчером. Тому, стратегія регулювання і графік споживання в локальній мережі потрібно враховувати для коректного розрахунку ємності акумулятора енергії гібридної электростанції. Показано застосування розробленої моделі на прикладі конкретної локальної мережі. Бібл. 9, рис. 8.*

**Ключові слова:** Моделювання, локальна мережа, гібридна электростанція.

Надійшла 18.04.2015  
Остаточний варіант 11.02.2016